







220x250 GH-R / 27x0,9

	0°	45°	60°	60°	 $\frac{b}{a \times b}$
	220	160	90	x	x
	230x150	160x90	90x90	x	230x120
	3x400V 50 Hz	0,75/1,1	30/65	2450x27x0,9	235
L	1410	B	600	Hmin	1490
			1750	V	930



220x250
GH-R

STANDARD OPTION

220-M2V

WGUN1

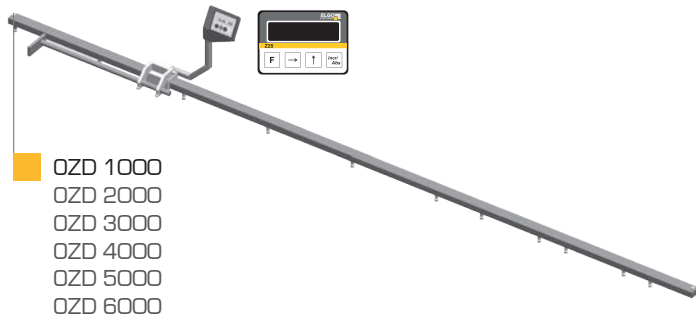
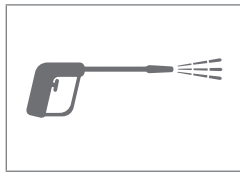
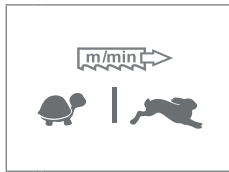

- OZD 1000
- OZD 2000
- OZD 3000
- OZD 4000
- OZD 5000
- OZD 6000

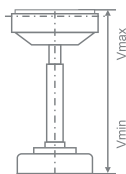
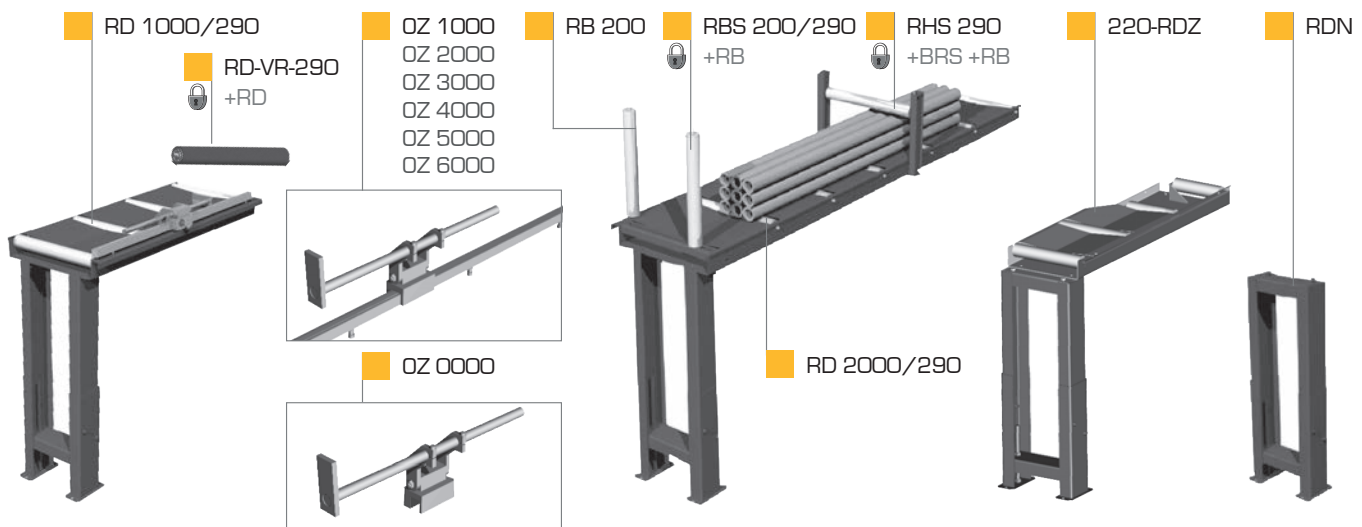

	S (mm)	Vmin (mm)	Vmax (mm)
R290	290	760	980

	S (mm)	L (mm)	Vmin (mm)	Vmax (mm)		
R	290	1000	760	980	4	200
		2000			7	

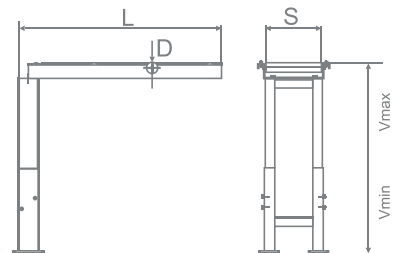

220x250 GH-R



CONTROL PANEL: GH

- výrobce si vyhrazuje právo provádět změny technických údajů, technické údaje odpovídají 1.1.2024 / producer has the right to make changes of technical data, technical data are valid on 1.1.2024

- pila na fotografii není vždy v základním provedení, uvedené rozměry odpovídají stroji v základním provedení / the machine in the picture is not always in the basic version, mentioned diameters are for machine in basic version

* doporučená hodnota. Při překročení doporučeného maximálního průměru není možné garantovat výkon pilového pásu! / recommended value. The blade performance cannot be guaranteed when the recommended diameter is exceeded!

- řezání svazků bez horního přitlaku / cutting of the bundle without top clamping



PEGAS - GONDA s.r.o.
Čs.armády 322, 684 01 Slavkov u Brna,
CZECH REPUBLIC

www.pegas-gonda.cz
00420-544 221 125 (126) | pegas@gonda.cz